

ACCURACY - GAUGE PRESSURE

Standard Accuracy Version

0 to 40% of Range: \pm (0.02% of Full Scale*)

40% to 110% of Range: \pm (0.05% of Reading)

Vacuum: \pm (0.25% of Full Scale**)

Includes all effects of linearity, hysteresis, repeatability, temperature, and stability for one year.

All models indicate vacuum, but vacuum specification applies to 15 psi, 30 psi, 100 psi, 300 psi, and 500 psi models only, and includes vacuum calibration points.

-S5 Accuracy Option

Vacuum to 110% of Range: \pm (0.05% of Full Scale*)

*Full Scale is 100% of the range

-S2 Accuracy Option

Vacuum to 110% of Range: \pm (0.02% of Full Scale*)

**Full Scale = -14.5 psig

ACCURACY - ABSOLUTE PRESSURE

16 psiA Range

-S5 Option: \pm (0.05% of Full Scale*)

All Absolute Ranges

Includes all effects of linearity, hysteresis, repeatability, temperature, and stability for one year.

Easily switch between gauge (sealed gauge) and absolute pressure measurement.

16 psiA Range

Only available with -S5 accuracy option.

Calibrated in Vertical Orientation. Orientation Effect = \pm 0.004 psi.

1000 psiA Ranges and Above

All models indicate pressure from 0 psiA to Full Scale, but are only specified from 15 psiA to Full Scale.

*Full Scale is 100% of the range.

100 and 500 psiA Ranges

0 to 40% of Range: \pm (0.02% of Full Scale*)

40% to 110% of Range: \pm (0.05% of Reading)

-S2 Option: \pm (0.02% of Full Scale*)

-S5 Option: \pm (0.05% of Full Scale*)

1000, 2000, 3000, 5000, 10 000, 15 000 psiA Ranges

15 psiA to 40% of Range: \pm (0.02% of Full Scale*)

40% to 110% of Range: \pm (0.05% of Reading)

-S2 Option: \pm (0.02% of Full Scale*)

-S5 Option: \pm (0.05% of Full Scale*)

XP3i Pressure Gauge psi

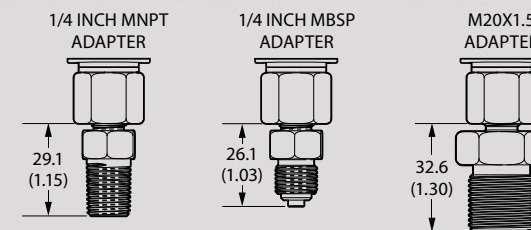
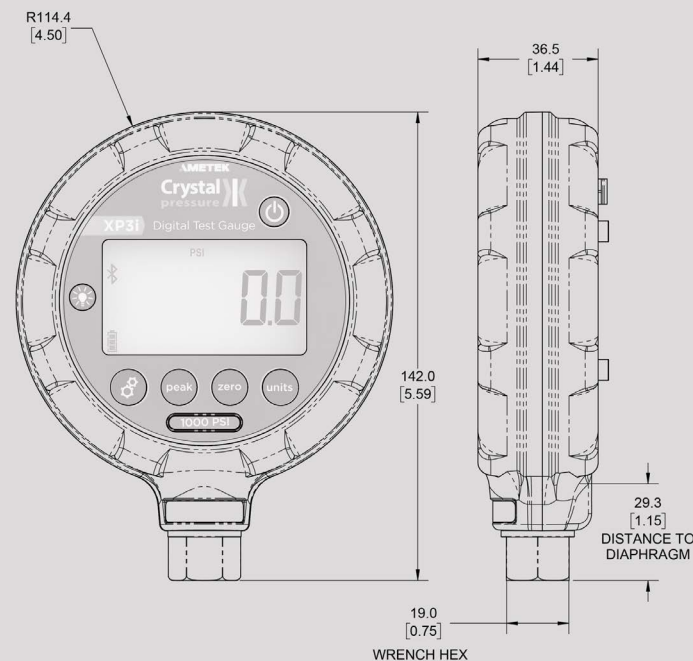

ADDITIONAL SENSOR LENGTH WITH OPTIONAL FITTING ADAPTERS

OPERATING TEMPERATURE

Fully Compensated Range: **-20 to 50° C (-4 to 122° F)**

Fully temperature compensated temperature range. No change in accuracy over the specified temperature range.

DISPLAY

Screen: **5.5 digits**

LCD readable in all conditions with two level backlight.

Single Line Display: **17 mm (0.68") high**

PSV mode is for Pressure Safety Valve testing. Configure using [CrystalControlWeb](http://CrystalControlWeb.com). (Configuration is available at [crystalcontrolweb.com](http://CrystalControlWeb.com).)

Dual Line Display: **Main Display: 16.8 mm (0.66")**
Secondary Display: 7.1 mm (0.28")

Display Rate: **4 readings/second (standard)**

POWER / COMMUNICATION

3 x AA: **1500 hours, typical***

*Uses 3 alkaline AA (LR6) batteries. *Typical battery life when operating without backlight or Bluetooth communication.*

Ultra Low Power: **> 1 year, typical****

May be powered via the USB port when operating outside the hazardous environment. Optional USB adapter available.

Digital Interface: **USB Type C**

***Enabled when datalogging interval is 20 minutes or longer.*

Bluetooth Low Energy: **Version 5.4, up to 100 feet typical**

For hazardous location product warnings and approved batteries, refer to the operation manual.

ENCLOSURE

Weight: **580 g (20.7 oz)**

Weight includes batteries.

Rating: **IP66 and IP67**

Submersible to 1 m for 30 minutes [IEC 60529].

Housing: **Diecast aluminum**

Thick nickel plating over low copper, marine grade aluminum.

Vibration: **10-500 Hz, 50 m/s²**

LCD protected from impact damage by 1.5 mm (0.06") thick polycarbonate lens under polyester window - no glass.

Shock: **15 g, 11 ms**

Skydrol® compatible.

Surface: **Fully static dissipative* to avoid build-up of electrostatic charge on portable equipment (incl. boot).****

Vibration and Shock tested to IEC 60068.

**Meeting EN IEC 60079-0:2018 requirements.*

***For hazardous location product warnings, refer to the operation manual.*

CERTIFICATIONS



II 1G Ex ia IIC T3...T4 Ga
FTZU 23 ATEX 0015X



Ex ia IIC T3...T4 Ga
IECEX FTZU 23.0017X



CSA24CA80188655X - Exia Intrinsically Safe - Class I, Div 1, Grp A, B, C and D, T4/T3C. Class I, Zone 0, AEx ia IIC, T3C...T4 Ga. For hazardous location product warnings, refer to the operation manual.



XP3i complies with the ATEX, RoHS, Pressure Equipment, and Radio Equipment Directives. (Includes Bluetooth.)



XP3i complies with the Australian Radiocommunications (Electromagnetic Compatibility) Standard 2008. (Includes Bluetooth.)



Bluetooth, USA: **FCC ID: 2BD5G001**
Bluetooth, Canada: **IC: 31893-001**
Bluetooth, Japan: **205-240004**

MIL-STD-810H - Withstands 5 foot drop (without protective boot) and 10 foot drop (with boot) to steel plate for 6 orientations.

DATALOGGING

- Capacity: **Greater than 200M data points**
- Storage Type: **Non-volatile flash memory**
- Minimum Interval: **5 Hz / five per second**
- Maximum Interval: **24 hours**
- Transfer Rates: **USB 5-10x faster than Bluetooth**

The One-Time Upgrade purchase allows the XP3i to log readings. This may be purchased at the time of order, or an upgrade package may be purchased afterwards.

Additional data features, and a demonstration mode are available at the link below:



SENSOR

- Wetted Materials: (WRENCH TIGHT) **316 stainless steel**
(FINGER TIGHT) **316 stainless steel and Viton® (internal o-ring)**
- Diaphragm Seal Fluid: **Silicone Oil**
- Connection: **Crystal CPF♦ Female**

All welded construction on sensors above 15 psi. (The 15 psi sensor has a Viton o-ring seal.)

Metal to metal cone seal; O-ring can be removed if necessary.

Optional connection on back.

1/4" male NPT adapter included unless BSP or M20 is specified.

1/4" medium pressure tube system compatible with HiP LM4 and LF4 Series, Autoclave Engr SF250CX Male and Female Series.

♦U.S. Patent No. 8,794,677

STORAGE TEMPERATURE

Temperature Range: **-40 to 75° C (-40 to 167° F)**

OVER-PRESSURE (ABSOLUTE AND GAUGE PRESSURES)

Range	Specified to	Over-Load Warning	Potential Sensor Damage
15 psi/16 psiA	16.5 psi	17.25 psi / 18.4 psiA	45 psi
30 psi	33 psi	34.5 psi	90 psi
100 psi	110 psi	115 psi	200 psi
300 psi	330 psi	345 psi	600 psi
500 psi	550 psi	575 psi	1000 psi
1000 psi	1100 psi	1150 psi	2000 psi
2000 psi	2200 psi	2300 psi	4000 psi
3000 psi	3300 psi	3450 psi	4500 psi
5000 psi	5500 psi	5750 psi	7500 psi
10000 psi	11000 psi	11500 psi	15000 psi
15000 psi	16500 psi	17250 psi	19500 psi

All ranges are specified to 110% of their range.

As a precaution, the "Over-Load Warning" will occur at 115% of the range, and the display will alternate between OL and the current reading until the pressure returns below 115% of the range.

The potential sensor damage is an estimated value, based on tests, at which permanent sensor damage is likely to occur.

STANDARD DELIVERY

- XP3i Gauge
- Online Manual
- ISO 17025 Accredited Calibration Certificate, NIST Traceable. Includes Data at Multiple Temperatures, Covering the Full Temperature Compensated Range. (Proving temperature compensation - for each gauge individually.)
- Velcro Strap (except the -RP and -F4 options)
- 3 x AA Batteries
- CrystalConnect Mobile App (available in the app stores)
- Free PC Configuration at crystalcontrolweb.com
- CPF Connection Fitting (ranges 10 000 psi and lower)

ACCESSORIES - NOT INTRINSICALLY SAFE EXCEPT P/N 7095

- **Protective Boot P/N 7095**
- **Magnetic Hanging Strap P/N 5203**
- **USB Cable USB-C/USB-A P/N 6885**
- **USB Universal Adapter, Wall Mount, USB-A P/N 7190**
- **Waterproof Carrying Case P/N 2888**

COMPLEMENTARY PRODUCTS

Crystal Engineering offers a wide range of products that work with the XP3i:

- [Discounted three year calibration program \(NA only\)](#)
- [Fittings that connect without tools, safely and without leaks](#)
- [Lightweight, super flexible high pressure hoses](#)
- [Pneumatic hand pumps](#)
- [Hydraulic hand pumps](#)
- [Portable pressure comparators](#)

*Autoclave Engineers Fluid Components is a division of Snap-tite, Inc. *HiP is High Pressure Equipment Company.

*Viton is a registered trademark of DuPont Performance Elastomers. *Skydrol is a registered trademark of Monsanto Chemical Corp.

RANGE & RESOLUTION TABLES

Gauge Pressure		Display Resolution									
P/N	Range (psi)	psi	in H ₂ O	in Hg	mm Hg	mm H ₂ O	kg/cm ²	bar	mbar	kPa	MPa
15PSI	15	0.001	0.01	0.001	0.01	1	0.0001	0.0001	0.1	0.01	0.00001
30PSI	30	0.001	0.01	0.001	0.1	1	0.0001	0.0001	0.1	0.01	0.00001
100PSI	100	0.01	0.1	0.01	0.1	1	0.0001	0.0001	0.1	0.01	0.00001
300PSI	300	0.01	0.1	0.01	1		0.001	0.001	1	0.1	0.0001
500PSI	500	0.01	1	0.1	1		0.001	0.001	1	0.1	0.0001
1KPSI	1000	0.1		0.1			0.001	0.001		0.1	0.0001
2KPSI	2000	0.1		0.1			0.01	0.01		1	0.001
3KPSI	3000	0.1		0.1			0.01	0.01		1	0.001
5KPSI	5000	0.1		1			0.01	0.01		1	0.001
10KPSI	10 000	1					0.01	0.01		1	0.001
15KPSI	15 000	1					0.01	0.01		1	0.001

Absolute Pressure		Display Resolution									
P/N	Range (psiA)	psi	in H ₂ O	in Hg	mm Hg	mm H ₂ O	kg/cm ²	bar	mbar	kPa	MPa
A16PSI	16	0.001	0.01	0.001	0.01	1	0.0001	0.0001	0.1	0.01	0.00001
A100PSI	100	0.01	0.1	0.01	0.1	1	0.0001	0.0001	0.1	0.01	0.00001
A500PSI	500	0.01	1	0.1	1		0.001	0.001	1	0.1	0.0001
A1KPSI	1000	0.1		0.1			0.001	0.001		0.1	0.0001
A2KPSI	2000	0.1		0.1			0.01	0.01		1	0.001
A3KPSI	3000	0.1		0.1			0.01	0.01		1	0.001
A5KPSI	5000	0.1		1			0.01	0.01		1	0.001
A10KPSI	10 000	1					0.01	0.01		1	0.001
A15KPSI	15 000	1					0.01	0.01		1	0.001

CPF Adapter Fitting is not included with 15KPSI or A15KPSI models.

ORDERING INFORMATION

Model	P/N	Dual Display	Accuracy	Adapter Type	Connection Location	Data logging
XP3I-	_____	_____	_____	_____	_____	_____
Standard:	No .. (omit)	0.05 of reading .. (omit)	NPT (omit)	Bottom (omit)	No (omit)	
Optional:	Yes.....-DD	0.02% of FS-S2	G 1/4 B-BSP	Back-RP	Yes.....-DL	
		0.05% of FS-S5	M20x1.5...-M20	Panel Mount ..-F4		

SAMPLE PART NUMBERS

XP3I-300PSI 300 psi standard gauge, with a 1/4" NPT pressure fitting.

XP3I-5KPSI-S2-BSP-DL 5000 psi gauge with 0.02% of FS accuracy, a 1/4" BSP pressure fitting, and Data logging.

XP3I-A10KPSI-DD-GWX-W 10 000 psi absolute pressure Dual Display gauge with a System G pump system and a waterproof carrying case.

► Ordering a Pump System Only

Any pump system, carrying case, and connection fittings for an XP3i pressure gauge may be ordered separately from the gauge. Enter XP3I-NONE followed by the Pump System part number and the Carrying Case option code.

SAMPLE PART NUMBER

XP3I-NONE-BHX-W System B pump system with a waterproof carrying case.







Pump System*	Carrying Case~
_____	_____
No Pump.... (omit)	
System A.... -AXX	Aluminum (omit)
System A.... -AHX	Waterproof..... -W
System B.... -BXX	
System B.... -BHX	~ The Waterproof Case is an option for Systems A, B, and C only.
System C.... -CXX	
System C.... -CHX	The Waterproof Case is the only option for Systems G and H.
System D.... -DOX	
System D.... -DWX	
System E.... -EOX	
System F.... -FOV	
System F.... -FWV	
System G.... -GOX	
System G.... -GWX	

AMETEK offers a variety of solutions for pressure generation and measurement. Our line of products for pressure generation includes everything from small pneumatic hand pumps to a precision, hydraulic pressure comparator capable of generating up to 15 000 psi / 1000 bar / 100 MPa.

All of our pumps may be ordered as part of a Pump System, complete with an XP3i and delivered in a sturdy carrying case with custom insert.

* Refer to the following page for a more detailed description of each pump system.

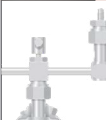
PUMP SYSTEMS OVERVIEW

Pump System	Part Number	Pressure Range	Pneumatic	Hydraulic	Hand Pump	Bench Top	Included Pump	Case Options		
								Aluminum	Waterproof (Pelican Case)	
System A	AXX	0 to 30psi /2 bar	■		■			■	(or)	■
	AHX	0 to 580 psi /40 bar	■		■			T-970-CPF		■
System B	BXX	-25 inHg to 30 psi /-0.85 to 2 bar	■		■			■	(or)	■
	BHX	-27 inHg to 580 psi /-0.91 to 40 bar	■		■			T-975-CPF		■
System C	CXX	0 to 3000 psi /200 bar		■ (Oil)	■			■	(or)	■
	CHX	0 to 5000 psi /350 bar		■ (Oil)	■			T-620H-CPF		■
System D	DOX	0 to 5000 psi /350 bar		■ (Oil)		■		■		
	DWX	0 to 5000 psi /350 bar		■ (Water)		■		P-018-CPF	■	
System E	EOX	0 to 10 000 psi /700 bar		■ (Oil)		■		■		
System F	FOV	0 to 15 000 psi /1000 bar		■ (Oil)		■		■		
	FWV	0 to 15 000 psi /1000 bar		■ (Water)		■		T-1-CPF	■	
System G	GOX	0 to 15 000 psi /1000 bar		■ (Oil)		■				■
	GWX	0 to 15 000 psi /1000 bar		■ (Water)		■		GaugeCalHP		
System H	HOX	-27 inHg to 580 psi /-0.91 to 40 bar	■		■			T-975-CPF (and)		■
		0 to 5000 psi /350 bar		■ (Oil)	■			T-620H-CPF		■