



PIE 422+Plus

Diagnostic Thermocouple
& Milliamp Calibrator

Best Thermocouple & Milliamp Calibrator on the market!

- **The only 2-in-1 thermocouple & full function milliamp calibrator on the market**

Only calibrator that combines ALL the functions of a diagnostic milliamp calibrator with the accuracy of a laboratory thermocouple calibrator.



- **Protect instruments & technicians from potentially dangerous catastrophic failures due to hidden loop problems**

Quickly diagnose ground fault and current leakage often caused by water in conduits and junction boxes with patented loop diagnostic technology (US Patent# 7,248,058).

- **Best accuracy & stability found in a handheld calibrator**

The internal cold junction is accurate to $\pm 0.05^{\circ}\text{C}$ and is traceable to NIST. Isothermal brass blocks with screw terminals allow for connection of bare thermocouple wires plus a miniature thermocouple connector for fast connections. More accurate than any other handheld thermocouple calibrator.

- **Verify Heat Treating Uniformity Survey Recorders & perform System Accuracy Tests**

The PIE 422Plus is capable of meeting the requirements of an AMS 2750 Field Test Instrument when certified by an accredited laboratory.

- **Half the size of the closest competitor & easiest to use**

Fits the palm of your hand like a cell phone and weighs less than a pound. Automatic indication of connections on the display for simple hookups. Carry it without worry - it comes protected with a rubber boot and rugged, low profile switches. Easy to operate even in dark areas of the plant with the backlit display.



Actual Size

Practical Instrument Electronics

82 E. Main Street Suite 3.14 • Webster, NY 14580 Tel: 585.872.9350 • Fax: 585.872.2638 • sales@piecal.com • www.piecal.com

More functions and better accuracy in one calibrator

- **Two complete calibrators**

Unlike any other combination thermocouple/milliamp calibrator on the market the PIE 422Plus includes a FULL function diagnostic milliamp calibrator that sources and reads 0.000 to 24.000 mA, simulates two wire transmitters, powers and measures transmitters with its internal 24V supply, has a built-in 250 ohm resistor for HART compatibility, and PIE's patented Ground Leak detection. Competitive calibrators allow you to calibrate temperature transmitters but don't have the ability to test other instruments in a 4 to 20 milliamp loop.

The other half of the calibrator sources and reads thermocouple types J, K, T, E, R, S, B, N, G, C, D, L (J-DIN), U (T-DIN), P (Platinel II), and from -13.000 to 80.000 mV.

- **Protect instruments & technicians from potentially dangerous catastrophic failures due to hidden loop problems**

It's important to find hidden loop problems BEFORE they become cause product problems or catastrophic failures. Only PIE Calibrators have Ground Leak Detection that can detect these problems.

Some technicians routinely check their critical loops for ground faults and current leaks using PIE's Ground Leak detection as part of their preventative maintenance programs. When a significant leak or fault is detected it is located and fixed before catastrophic failures occur.

Sometimes the control room detects a problem that isn't fixed with routine calibration of the instruments. The technician then reaches for a calibrator with Ground Leak Detection to power up the loop and confirm that the issue is hiding somewhere in the loop wiring.

- **State of the art accuracy & stability**

It's important to have a calibrator that is at least 4 times more accurate than the instruments being calibrated. Both the milliamp and thermocouple sections were designed with state of the art components that are the most accurate and stable found in a handheld calibrator.

The internal cold junction is accurate to $\pm 0.05^{\circ}\text{C}$ and is traceable to NIST. The sensor is thermally bonded to an isothermal mass including brass blocks with screw terminals for connection of bare thermocouple wires along with a miniature thermocouple connector for fast connections. An extremely stable voltage reference and low drift components make it more accurate than other handheld thermocouple calibrators.

- **Verify Heat Treating Uniformity Survey Recorders & perform System Accuracy Tests**

The AMS 2750 standard calls out particular specifications that need to be met for a calibrator to be used as a Field Test Instrument. The Field Test Instrument is then used to verify the thermocouple measuring thermometers and controllers that are used in the heat treating of parts for the aerospace industry.

The PIE 422Plus is capable of meeting the requirements of an AMS 2750 Field Test Instrument when certified by an accredited laboratory.

- **Half the size of the closest competitor & easiest to use**

Don't get tired by lugging around heavy oversized test equipment when you can carry the palm sized PIE 422Plus that weighs less than a pound. It comes with a deluxe carrying case for simple, hands free operation. The simple and intuitive double click menu and EZ-Check switch are faster and easier to use than calibrator with lots of confusing buttons or with confusing menus. And with the optional magnet strap you can attach it to a panel or loop the strap around a conduit or pipe.

Many calibrators don't have automatic stepping and ramping while others limit you to selecting either slow or fast fixed 25% steps. The PIE 422Plus lets you choose between 2, 3, 5, 11 and 21 steps to automatically increment the output in 100%, 50%, 25%, 10% or 5% of span. Select the step time to match your system from 5, 6, 7, 8, 9, 10, 15, 20, 25, 30 and 60 seconds.

Prevent Small Problems from Becoming Major Plant Failures

The PIE 422Plus offers powerful troubleshooting tools that offer visibility to the health of your loop that is not possible with any calibrator brand on the market. Ground Leak Detection allows technicians to find and fix undetected problems before they cause quality issues or become catastrophic failures - ending in poor product, injury, loss of life, or equipment damage. Common loop problems caused by moisture, corrosion and contamination left unchecked can lead to dangerous conditions that are easily avoided with the innovation technology in the PIE 422Plus.

Even the most common small errors caused by loop wiring issues can lead to inferior product, lost production time and risk to personnel. Intrinsically safe loops are protected by barriers only against extreme overvoltage and over current conditions but allowing small but significant ground faults to go undetected. PIE's unique and powerful Ground Leak Detection technology quickly and easily finds a fault that would otherwise go undetected. These undetected faults could lead to potentially disastrous outcomes.

Have you ever replaced a "faulty" transmitter only to find the problem was somewhere else in the loop? And did you end up throwing the transmitter away after you fixed the other problem "just in case" the transmitter was faulty? If you find a loop where the transmitter is calibrated correctly but all the readings elsewhere in the loop have a fixed offset this is due to a Zero Shift. This Zero Shift is typically caused by some of the current in the loop bypassing the transmitter. If you have some loops that are erratic after it rains there may be moisture present in a junction box or where insulation has broken down.

Only a PIE Calibrator with patented Ground Leak Detection can find all these hidden problems. Turn on Ground Leak Detection and use the PIE 422Plus to power up the loop. Any current that isn't controlled by the transmitter or other current control element will be clearly indicated as leakage on the PIE 422Plus display.

Ground Leak detection allows technicians to troubleshoot loop problems with ease and confidence - minimizing risk and maximizing process uptime.

Hidden Problem Found with Ground Leak Detection

Safe loop

Sealed junction box is dry and the control system is operating within parameters.

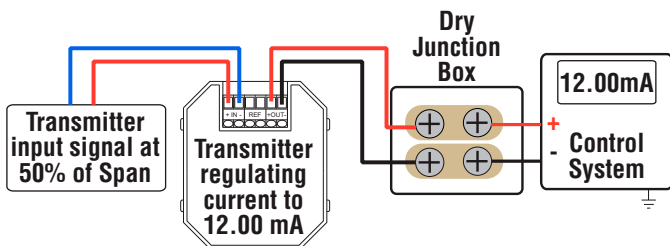

Dangerous loop

Sealed junction box is wet* and the control system is operating with a fixed offset of 0.51 milliamps!

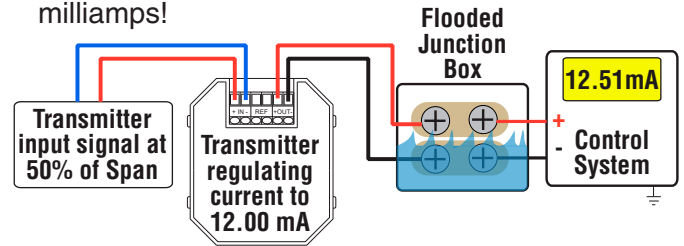

* The value of the current leak increases when the water in the junction box is contaminated with rust, salt or process chemicals.

Dangerous loop left undetected

The flooded junction box goes undetected and the control system potentially goes further out of control until...

OR

Disaster averted

Hidden problem is detected by the PIE 422Plus. The flooded sealed junction box is emptied and the control system is once again operating within parameters. The product, equipment, and personnel are safe!

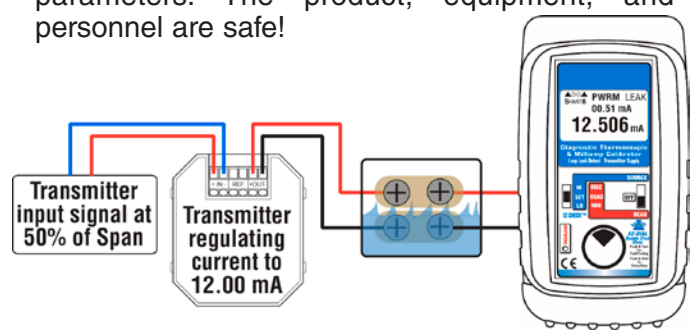
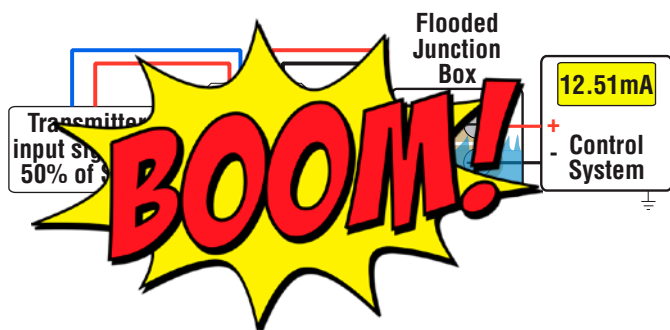



**Magnetic Hanging Strap
(Optional)**



**Deluxe Hands Free
Carrying Case (Included)**

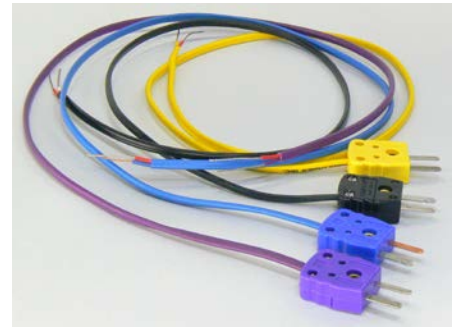

**Thermocouple Wire Kit 1
J, K, T & E (Optional)**



**Thermocouple Wire Kit 2
B, R/S, N (Optional)**

Included:

- Blue Rubber Boot, Four "AA" Alkaline batteries, Certificate of Calibration
- Deluxe Hands Free Carrying Case Part No. 020-0211
- Evolution mA/V Wire Kit Part No. 020-0207
- 1 Red & 1 Black Lead with Banana Plugs & Alligator Clips

Optional:

- T/C Wire Kit 1 for Types J, K, T & E Part No. 020-0202
- T/C Wire Kit 2 for Types B, R/S & N Part No. 020-0203
- Three feet (1 meter) of T/C extension wire, stripped on one end with a miniature T/C male connector on the other end.
- Magnetic Hanging Strap Part No. 020-0236
- Ni-MH Charger with 4 Ni-MH AA Batteries Part No. 020-0103

Thermocouple, Millivolt & Milliamp Connections

Simulating or reading thermocouples requires the use of thermocouple or extension grade thermocouple wire. Plug thermocouple wires into the miniature thermocouple jack or place bare thermocouple wires onto the brass block under the screws.

The PIE 422Plus has two banana jacks (1+ and 2-) mounted in the top end of the housing. These are not temperature compensated and are to be used only for millivolt signals. The two banana jacks (5+ and 6-) are for all milliamp signals.

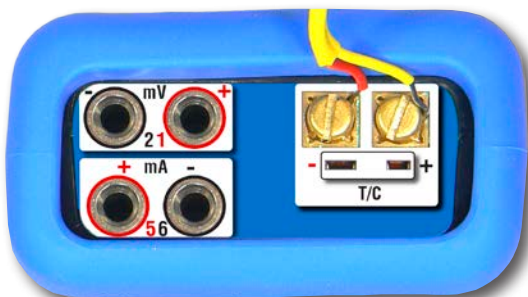

PIE 422Plus Specifications

(Unless otherwise indicated all specifications are rated from a nominal 23°C, 70% RH for 1 year from calibration)

General	
Operating Temperature Range	-25 to 60 °C (-10 to 140 °F)
Relative Humidity Range	10 % ≤RH ≤90 % (0 to 35 °C), Non-condensing 10 % ≤RH ≤ 70 % (35 to 60 °C), Non-condensing
Temperature Drift	± 0.01% of span outside of 23°C ±10 °C (73°C ±18 °F)
Size	5.63 x 3.00 x 1.60 in, 143 x 76 x 41 mm (L x W x H)
Weight	12.1 ounces, 0.34 kg (including boot & batteries)
Batteries	Four "AA" Alkaline 1.5V (LR6)
Battery Life	25 Hours Thermocouple, 8 Hours milliamp
Isolation: Voltage	60V rms between all milliamp functions/Read V DC and Source V DC/Thermocouple
Normal Mode Rejection	50/60 Hz, 50 dB
Common Mode Rejection	50/60 Hz, 120 dB
Optional NiMh Rechargeable battery kit	Charger, four NiMh batteries [Part # 020-0103]
Low Battery	Low battery indication with nominal 1 hour of operation left
Protection against misconnection	Over-voltage protection to 60 V dc (rated for 30 seconds)
Display	High contrast graphic liquid crystal display. LED backlighting for use in low lit areas.

Read mA	
Ranges and Resolution	0.000 to 24.000 mA or -25.00 to 125.00% of 4-20 mA
Accuracy	≤ ± (0.02 % of Reading + 0.003 mA)
Voltage burden	≤ 2V at 24 mA
Overload/Current limit protection	25 mA nominal

Source mA / Power & Measure Two Wire Transmitters & PWRM LEAK	
Ranges and Resolution	0.000 to 24.000 mA or -25.00 to 125.00% of 4-20 mA
Accuracy	≤ ± (0.02 % of Reading + 0.003 mA)
Loop compliance voltage	≥ 24 DCV @ 20.00mA
Loop drive capability	1200 Ω at 20 mA for 15 hours nominal; 950 Ω with Hart Resistor or leak detection running

mA 2-Wire Transmitter Simulation	
Accuracy	Same as Source/Power & Measure
Voltage burden	≤ 2V at 20 mA
Overload/Current limit protection	24 mA nominal
Loop voltage limits	2 to 60 VDC (fuse-less protected from reverse polarity connections)

Warranty

Our equipment is warranted against defective material and workmanship (excluding batteries) for a period of three years from the date of shipment. Claims under warranty can be made by returning the equipment prepaid to our factory. The equipment will be repaired, replaced or adjusted at our option. The liability of Practical Instrument Electronics (PIE) is restricted to that given under our warranty. No responsibility is accepted for damage, loss or other expense incurred through sale or use of our equipment. Under no condition shall Practical Instrument Electronics, Inc. be liable for any special, incidental or consequential damage.

Source Thermocouple	
Accuracy	±(0.008% of Reading + 0.006 mV)
Cold Junction Compensation	± 0.09°F (±0.05 °C) - Thermistor traceable to NIST for 11 years
Millivolt Range	-13.000 to 80.000 mV
Output Impedance	< 0.3 Ohms
Source Current	> 20 mA (drives 80 mV into 10 Ohms)
Noise	≤ 4 microvolts p-p for frequencies of 10 Hz or below

Read Thermocouple	
Accuracy	±(0.008% of Reading + 0.006 mV)
Cold Junction Compensation	± 0.09°F (±0.05 °C) - Thermistor traceable to NIST for 11 years
Millivolt Range	-13.000 to 80.000 mV
Input Impedance	> 10 Megohms
Open Thermocouple Threshold Pulse	10,000 Ohms nominal < 10 microamp pulse for 400 milliseconds
Normal Mode Rejection	50/60 Hz, 50 dB
Common Mode Rejection	50/60 Hz, 120 dB







Additional Information







PIE Calibrators are designed, assembled, and calibrated in the USA. This product is calibrated on equipment traceable to NIST and includes a Certificate of Calibration. Test Data is available for an additional charge.

Practical Instrument Electronics recommends a calibration interval of one year. Contact your local representative for recalibration and repair services.

Thermocouple Ranges & Accuracies

Based on $\leq \pm (0.008 \% \text{ of Reading} + 0.006 \text{ mV})$

T/C	Degrees C Range	°C	Degrees F Range	°F	T/C Material
J 	-200.0 to -180.0	$\pm 0.3^\circ$	-328.0 to -292.0	$\pm 0.5^\circ$	+Iron -Constantan
	-180.0 to -50.0	$\pm 0.2^\circ$	-292.0 to -58.0	$\pm 0.4^\circ$	
	-50.0 to 500.0	$\pm 0.1^\circ$	-58.0 to 932.0	$\pm 0.2^\circ$	
	500.0 to 1200.0	$\pm 0.2^\circ$	932.0 to 2192.0	$\pm 0.4^\circ$	
K 	-230.0 to -100.0	$\pm 0.6^\circ$	-382.0 to -148.0	$\pm 1.1^\circ$	+ Chromel® -Alumel®
	-100.0 to 1050.0	$\pm 0.2^\circ$	-148.0 to 1922.0	$\pm 0.4^\circ$	
	1050.0 to 1371.1	$\pm 0.3^\circ$	1922.0 to 2500.0	$\pm 0.5^\circ$	
T 	-260.0 to -200.0	$\pm 1.0^\circ$	-436.0 to -328.0	$\pm 1.8^\circ$	+Copper -Constantan
	-200.0 to -50.0	$\pm 0.5^\circ$	-328.0 to -58.0	$\pm 0.9^\circ$	
	-50.0 to 0.0	$\pm 0.2^\circ$	-58.0 to 32.0	$\pm 0.4^\circ$	
	0.0 to 400.0	$\pm 0.1^\circ$	32.0 to 752.0	$\pm 0.2^\circ$	
E 	-240.0 to -200.0	$\pm 0.4^\circ$	-400.0 to -328.0	$\pm 0.7^\circ$	+Chromel -Constantan
	-200.0 to -100.0	$\pm 0.2^\circ$	-328.0 to -148.0	$\pm 0.4^\circ$	
	-100.0 to 850.0	$\pm 0.1^\circ$	-148.0 to 1562.0	$\pm 0.2^\circ$	
	850.0 to 1000.0	$\pm 0.2^\circ$	1562.0 to 1832.0	$\pm 0.4^\circ$	
R 	-18.3 to 250.0	$\pm 1.2^\circ$	-1.0 to 482.0	$\pm 2.2^\circ$	+Pt/13Rh -Platinum
	250.0 to 750.0	$\pm 0.6^\circ$	482.0 to 1382.0	$\pm 1.1^\circ$	
	750.0 to 1600.0	$\pm 0.5^\circ$	1382.0 to 2192.0	$\pm 0.9^\circ$	
	1600.0 to 1767.8	$\pm 0.6^\circ$	2192.0 to 3214.0	$\pm 1.1^\circ$	
S 	-18.3 to 100.0	$\pm 1.2^\circ$	-1.0 to 212.0	$\pm 2.1^\circ$	+Pt/10Rh -Platinum
	100.0 to 400.0	$\pm 0.8^\circ$	212.0 to 752.0	$\pm 1.4^\circ$	
	400.0 to 1700.0	$\pm 0.6^\circ$	752.0 to 3092.0	$\pm 1.1^\circ$	
	1700.0 to 1767.8	$\pm 0.7^\circ$	3092.0 to 3214.0	$\pm 1.3^\circ$	
B 	315.6 to 550.0	$\pm 1.8^\circ$	600 to 1022.0	$\pm 3.2^\circ$	+Pt/30Rh -Pt/6Rh
	550.0 to 900.0	$\pm 1.1^\circ$	1022.0 to 1652.0	$\pm 2.0^\circ$	
	900.0 to 1150.0	$\pm 0.7^\circ$	1652.0 to 2102.0	$\pm 1.3^\circ$	
	1150.0 to 1820.0	$\pm 0.6^\circ$	2102.0 to 3308.0	$\pm 1.1^\circ$	

T/C	Degrees C Range	°C	Degrees F Range	°F	T/C Material
N 	-230.0 to -180.0	$\pm 1.0^\circ$	-382.0 to -292.0	$\pm 1.8^\circ$	+Microsil -Nisil
	-180.0 to -50.0	$\pm 0.5^\circ$	-292.0 to -58.0	$\pm 0.9^\circ$	
	-50.0 to 1100.0	$\pm 0.2^\circ$	-58.0 to 2012.0	$\pm 0.4^\circ$	
	1100.0 to 1300.0	$\pm 0.3^\circ$	2012.0 to 2372.0	$\pm 0.5^\circ$	
G (W) 	100.0 to 150.0	$\pm 1.2^\circ$	212.0 to 302.0	$\pm 2.2^\circ$	+Tungsten -W26/Re
	150.0 to 400.0	$\pm 0.8^\circ$	302.0 to 752.0	$\pm 1.4^\circ$	
	400.0 to 1700.0	$\pm 0.4^\circ$	752.0 to 3092.0	$\pm 0.7^\circ$	
	1700.0 to 2320.0	$\pm 0.7^\circ$	3092.0 to 4208.0	$\pm 1.3^\circ$	
C (W5) 	-1.1 to 1500	$\pm 0.5^\circ$	30.0 to 2372.0	$\pm 0.9^\circ$	+W5/Re -W26/Re
	1500 to 1900	$\pm 0.6^\circ$	2372.0 to 3452.0	$\pm 101^\circ$	
	1900.0 to 2100.0	$\pm 0.7^\circ$	3452.0 to 3812.0	$\pm 1.3^\circ$	
	2100.0 to 2320.0	$\pm 0.9^\circ$	3812.0 to 4208.0	$\pm 1.6^\circ$	
D (W3) 	-1.1 to 50.0	$\pm 0.6^\circ$	30.0 to 122.0	$\pm 1.1^\circ$	+W3/Re -W25/Re
	50.0 to 1400.0	$\pm 0.4^\circ$	122.0 to 2552.0	$\pm 0.7^\circ$	
	1400.0 to 1800.0	$\pm 0.5^\circ$	2552.0 to 3272.0	$\pm 0.9^\circ$	
	1800.0 to 2320.0	$\pm 0.9^\circ$	3272.0 to 4208.0	$\pm 1.6^\circ$	
P <small>Platinel®</small> 	0.0 to 1000.0	$\pm 0.2^\circ$	32.0 to 1832.0	$\pm 0.4^\circ$	+Pd55/Pt31/Au14 -Au65/Pd35
	1000.0 to 1395.0	$\pm 0.3^\circ$	1832.0 to 2543.0	$\pm 0.5^\circ$	
DIN Colors					
L J-DIN 	-200.0 to -50.0	$\pm 0.2^\circ$	-328.0 to -58.0	$\pm 0.4^\circ$	+Iron -Constantan
	-50.0 to 500.0	$\pm 0.1^\circ$	-58.0 to 932.0	$\pm 0.2^\circ$	
	500.0 to 900.0	$\pm 0.2^\circ$	932.0 to 1652.0	$\pm 0.4^\circ$	
U T-DIN 	-200.0 to -75.0	$\pm 0.3^\circ$	-328.0 to -103.0	$\pm 0.5^\circ$	+Copper -Constantan
	-75.0 to 100.0	$\pm 0.2^\circ$	-103.0 to 212.0	$\pm 0.4^\circ$	
	100.0 to 600.0	$\pm 0.1^\circ$	212.0 to 1112.0	$\pm 0.2^\circ$	

Note: Doesn't include cold junction error of $\pm 0.05^\circ\text{C}$



Practical Instrument Electronics

82 Est Main Street Suite 3.14 Webster, NY 14580

Tel: 585.872.9350 • Fax: 585.872.2638

sales@piecal.com • www.piecal.com

Copyright © 2017 All rights reserved 422Plus-9001 - Rev A 23 June 2017

Available From: