



# PIE 525+Plus

## Diagnostic Thermocouple & Milliamp Calibrator

### Best Thermocouple, RTD & Milliamp Calibrator on the market!

- **The only 3-in-1 thermocouple, RTD, and full function milliamp calibrator on the market**

Only calibrator that combines ALL the functions of a diagnostic milliamp calibrator with the accuracy of a laboratory thermocouple and RTD calibrator.



- **Protect instruments & technicians from (potentially dangerous) catastrophic failures due to hidden loop problems**

Quickly diagnose ground fault and current leakage often caused by water in conduits and junction boxes with patented loop diagnostic technology (US Patent# 7,248,058).

- **Best accuracy & stability found in a handheld calibrator**

The internal cold junction is accurate to  $\pm 0.05^{\circ}\text{C}$ , traceable to NIST, and more accurate than any other handheld thermocouple calibrator.

- **Compatible with ALL process instruments**

No competitor's calibrator is compatible with as many process instruments! Connect directly to the RTD inputs of smart transmitters, PLCs, DCS & multichannel recorders and verify their outputs or displays.

- **Find problems with troubleshooting tools**

Troubleshoot thermocouple probes by measuring the resistance of the cables and sensing element, allowing you to replace high resistance probes before they burn out. The PIE 525Plus automatically detects 2, 3 & 4 wire RTD connections and indicates broken wires with patented technology.

- **Verify Heat Treating Uniformity Survey Recorders & perform System Accuracy Tests**

The PIE 525Plus is capable of meeting the requirements of an AMS 2750 Field Test Instrument when certified by an accredited laboratory.

- **Half the size of the closest competitor and the easiest to use**

Fits the palm of your hand like a cell phone and weighs less than a pound. Automatic indication of connections on the display for simple hookups. Carry it without worry - it comes protected with a rubber boot and rugged, low profile switches. Easy to operate even in dark areas of the plant with the backlit display.



Actual Size

Practical Instrument Electronics

82 E. Main Street Suite 3.14 • Webster, NY 14580 Tel: 585.872.9350 • Fax: 585.872.2638 • sales@piecal.com • www.piecal.com

# More functions and better accuracy in one calibrator

- **Three complete calibrators**

Unlike any other combination thermocouple/milliamp calibrator on the market the PIE 525Plus includes a FULL function diagnostic milliamp calibrator that sources and reads 0.000 to 24.000 mA, simulates two wire transmitters, powers & measures transmitters with its internal 24V supply, has a built-in 250 ohm resistor for HART compatibility and PIE's patented Ground Leak Detection. Competitive calibrators allow you to calibrate temperature transmitters but don't have the ability to test other instruments in a 4 to 20 mA loop.

The two parts of the calibrator sources and reads both 14 thermocouples types and 12 RTD types to 0.01°F & °C.

- **Protect instruments & technicians from (potentially dangerous) catastrophic failures due to hidden loop problems**

It's important to find hidden loop problems BEFORE they cause product problems or catastrophic failures. Only PIE Calibrators have Ground Leak Detection that can detect these problems.

- **State of the art accuracy & stability**

It's important to have a calibrator that is at least 4 times more accurate than the instruments being calibrated. The milliamp, thermocouple & RTD sections were designed with state of the art components that are the most accurate and stable found in a handheld calibrator. The internal cold junction is accurate to  $\pm 0.05^{\circ}\text{C}$  and is traceable to NIST.

- **Verify Heat Treating Uniformity Survey Recorders & perform System Accuracy Tests**

The AMS 2750 standard calls out particular specifications that need to be met for a calibrator to be used as a Field Test Instrument. The Field Test Instrument is then used to verify the thermocouple measuring thermometers and controllers that are used in the heat treating of parts for the aerospace industry.

The PIE 525Plus is capable of meeting the requirements of an AMS 2750 Field Test Instrument when certified by an accredited laboratory.

- **Compatible with ALL process instruments**

Calibrating smart transmitters and PLCs is a problem for many electronic RTD calibrators. These instruments measure RTD sensors with a pulsed excitation current that is too fast for many calibrators to lock onto which causes errors in calibration. The PIE 525Plus has unique circuitry designed to accurately calibrate smart and multivariable transmitters, PLC inputs, and multichannel recorders. *PIE guarantees compatibility with all RTD instruments.*

- **Troubleshoot RTD sensors**

When you have an RTD input problem that is difficult to diagnose the PIE 525Plus makes it easy. When the calibrator is connected directly to the RTD sensor it will indicate on the display which wires are connected. This quickly points out if there is problem with the wiring or with the sensor itself. Secondary displays show you the resistance value of the RTD plus the magnitude and direction of the excitation current used by the instrument to measure an RTD sensor.

- **Troubleshoot Thermocouple sensors**

Save costs and improve uptime by replacing thermocouple probes as they are approaching the failure point. Replacing them too early increases your costs and waiting for them to fail can lead to expensive downtime charges. The PIE 525Plus measures the resistance of the cables and sensing element at the same time it displays the temperature in °C or °F while the probe is installed in the process. Probes with high resistance should be replaced before they burn out. Open thermocouples and thermocouples that have high resistance indicating impending failure are indicated by OPEN TC and the resistance value on the display.

- **Half the size of the closest competitor and the easiest to use**

Don't get tired by lugging around heavy oversized test equipment when you can carry the palm sized PIE 525Plus that weighs less than a pound. It comes with a deluxe carrying case for simple, hands free operation. The simple and intuitive double click menu and EZ-Check switch are faster and easier to use than calibrator with lots of confusing buttons or with confusing menus. And with the optional magnet strap you can attach it to a panel or loop the strap around a conduit or pipe.

Many calibrators don't have automatic stepping and ramping while others limit you to selecting either slow or fast fixed 25% steps. The PIE 525Plus lets you choose between 2, 3, 5, 11 and 21 steps to automatically increment the output in 100%, 50%, 25%, 10% or 5% of span. Select the step time to match your system from 5, 6, 7, 8, 9, 10, 15, 20, 25, 30 and 60 seconds.

## Prevent Small Problems from Becoming Major Plant Failures

The PIE 525Plus offers powerful troubleshooting tools that offer visibility to the health of your loop that is not possible with any calibrator brand on the market. Ground Leak Detection allows technicians to find and fix undetected problems before they cause quality issues or become catastrophic failures - producing poor product, injury, loss of life, or equipment damage. Common loop problems caused by moisture, corrosion and contamination left unchecked can lead to dangerous conditions that are easily avoided with the innovation technology in the PIE 525Plus.

Even the most common small errors caused by loop wiring issues can lead to inferior product, lost production time and risk to personnel. Intrinsically safe loops are protected by barriers only against extreme overvoltage and over current conditions but allowing small but significant ground faults to go undetected. PIE's unique and powerful Ground Leak Detection technology quickly and easily finds a fault that would otherwise go undetected. These undetected faults could lead to potentially disastrous outcomes.

Have you ever replaced a "faulty" transmitter only to find the problem was somewhere else in the loop? And did you end up throwing the transmitter away after you fixed the other problem "just in case" the transmitter was faulty? If you find a loop where the transmitter is calibrated correctly but all the readings elsewhere in the loop have a fixed offset this is due to a Zero Shift. This Zero Shift is typically caused by some of the current in the loop bypassing the transmitter. If you have some loops that are erratic after it rains there may be moisture present in a junction box or where insulation has broken down.

Only a PIE Calibrator with patented Ground Leak Detection can find all these hidden problems. Turn on Ground Leak Detection and use the PIE 525Plus to power up the loop. Any current that isn't controlled by the transmitter or other current control element will be clearly indicated as leakage on the PIE 525Plus display.

Ground Leak detection allows technicians to troubleshoot loop problems with ease and confidence - minimizing risk and maximizing process uptime.

### Hidden Problem Found with Ground Leak Detection

#### Safe loop

Sealed junction box is dry and the control system is operating within parameters.

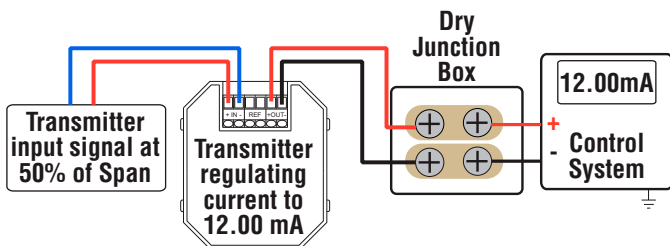

#### Dangerous loop

Sealed junction box is wet\* and the control system is operating with a fixed offset of 0.51 milliamps!

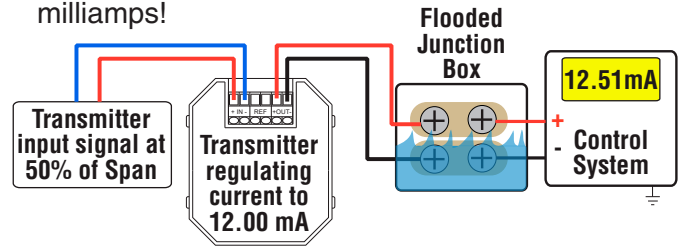

\* The value of the current leak increases when the water in the junction box is contaminated with rust, salt or process chemicals.

#### Dangerous loop left undetected

The flooded junction box goes undetected and the control system potentially goes further out of control until...

**OR**

#### Disaster averted

Hidden problem is detected by the PIE 525Plus. The flooded sealed junction box is emptied and the control system is once again operating within parameters. The product, equipment, and personnel are safe!

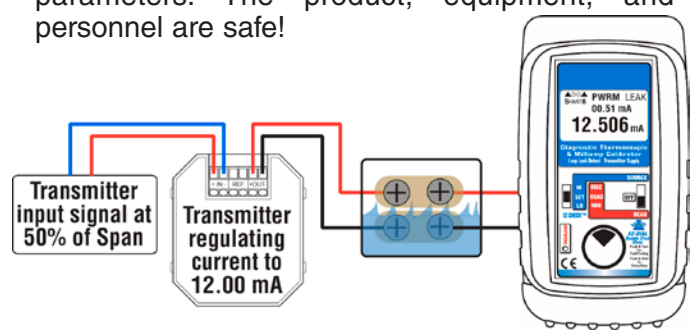
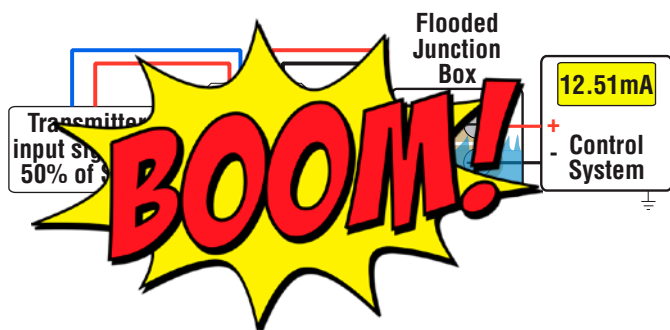



### Problem found with RTD Sensor Wiring

Here is an example of the PIE 525Plus reading a sensor with all 4 wires connected.



Here is an example where connections are made to a 4 wire sensor and the 525Plus indicates that only Wires 1, 2 & 4 are connected. There may be a loose connection or a break in wire 3 somewhere between the sensor and the 525Plus.



Only a calibrator with PIE's patented 2, 3 & 4 wire detection makes troubleshooting sensor wiring quick, easy and automatic. This is much simpler and faster than going through the process of testing each pair of wires to figure out which, if any, connection is loose or which wire is broken.

### Problem found with Thermocouple Probe Resistance

Here is an example of the PIE 525Plus reading a new sensor with low resistance. The resistance is approximately 100 ohms.



Here is a thermocouple junction inside the probe that is close to burning out. The thermocouple should be replaced before this happens as part of your preventative maintenance program.

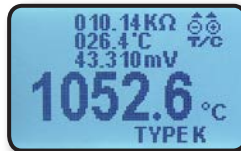

This probe indicated OPEN on the controller and shut down the process. The resistance is <10,000 ohms versus >100 ohms when new.



Only a calibrator with PIE's secondary display of thermocouple probe resistance makes troubleshooting thermocouples simple without requiring additional testing equipment. This saves time and money over replacing fully operational thermocouple too early or waiting for the thermocouples to fail.

## Thermocouple, Millivolt, RTD & Milliamp Connections

**Simulating or reading thermocouples requires the use of thermocouple or extension grade thermocouple wire.**

Plug thermocouple wires into the miniature thermocouple jack. The PIE 525Plus has two banana jacks (1+ and 2-) mounted in the top end of the housing. These are not temperature compensated and are to be used only for millivolt signals. The two banana jacks (5+ and 6-) are for all milliamp signals.



**Simulating or reading RTDs uses copper wire.**

Plug 2, 3 or 4 wires into the corresponding jacks on the calibrator. For RTD source the PIE 525Plus simulates the (+) RTD from jacks 1 & 4 and the (-) RTD from jacks 2 & 3. When reading an RTD sensor the PIE 525Plus uses patented circuitry to automatically detects if 2, 3 or 4 wires are connected. This is helpful to troubleshoot sensor connections.



## Accessories



**Magnetic Hanging Strap  
(020-0236 Optional)**



**Deluxe Hands Free  
Carrying Case (Included)**



**Evolution mA/V Test Leads  
(Included)**



**Evolution RTD Test Leads  
(Included)**

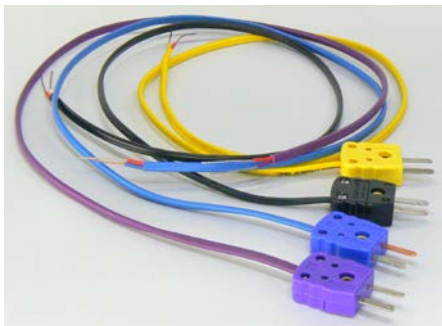

**Thermocouple Wire Kit 1  
J, K, T & E (Optional)**



**Thermocouple Wire Kit 2  
B, R/S, N (Optional)**

**Included:**

- Dark Blue Rubber Boot, Four "AA" Alkaline batteries, Certificate of Calibration
- Deluxe Hands Free Carrying Case Part No. 020-0211
- Evolution mA/V Wire Kit Part No. 020-0207
  - 1 Red & 1 Black Lead with Banana Plugs & Alligator Clips
- Evolution RTD Wire Kit Part No. 020-0206
  - 2 Red & 2 Black Leads with Banana Plugs & Spade Lugs

**Optional:**

- T/C Wire Kit 1 for Types J, K, T & E Part No. 020-0202
- T/C Wire Kit 2 for Types B, R/S & N Part No. 020-0203
  - Three feet (1 meter) of T/C extension wire, stripped on one end with a miniature T/C male connector on the other end.
- Magnetic Hanging Strap Part No. 020-0236
- Ni-MH Charger with 4 Ni-MH AA Batteries Part No. 020-0103

# PIE 525Plus Specifications

(Unless otherwise indicated all specifications are rated from a nominal 23°C, 70% RH for 1 year from calibration)

General	
Operating Temperature Range	-25 to 60 °C (-10 to 140 °F)
Storage Temp. Range	-30 to 60 °C (-22 to 140 °F)
Relative Humidity Range	10 % ≤RH ≤90 % (0 to 35 °C), Non-condensing
	10 % ≤RH ≤ 70 % (35 to 60 °C), Non-condensing
Temperature Drift	± 0.01% of span outside of 23°C ±10 °C (73°C ±18 °F)
Size	5.63 x 3.00 x 1.60 in, 143 x 76 x 41 mm (L x W x H)
Weight	12.1 ounces, 0.34 kg (including boot & batteries)
Batteries	Four "AA" Alkaline 1.5V (LR6)
Battery Life (Typical)	25 Hours Thermocouple or RTD, 8 Hours milliamp
Isolation: Voltage	60V rms between all milliamp functions/Read V DC and Source V DC/Thermocouple/Ohms/RTD
Normal Mode Rejection	50/60 Hz, 50 dB
Common Mode Rejection	50/60 Hz, 120 dB
Optional NiMh Rechargeable battery kit	Charger, four NiMh batteries [Part # 020-0103]
Low Battery	Low battery indication with nominal 1 hour of operation left
Protection against misconnection	Over-voltage protection to 60V dc (rated for 30 seconds)
Display	High contrast graphic liquid crystal display. LED backlighting for use in low lit areas.

Read mA	
Ranges and Resolution	0.000 to 24.000 mA or -25.00 to 125.00% of 4-20 mA
Accuracy	≤ ± (0.02 % of Reading + 0.003 mA)
Voltage burden	≤ 2V at 24 mA
Overload/Current limit protection	25 mA nominal

Source mA / Power & Measure Two Wire Transmitters & PWRM LEAK	
Ranges and Resolution	0.000 to 24.000 mA or -25.00 to 125.00% of 4-20 mA
Accuracy	≤ ± (0.02 % of Reading + 0.003 mA)
Loop compliance voltage	≥ 24 DCV @ 20.00mA
Loop drive capability	1200 Ω at 20 mA 950 Ω with Hart Resistor or leak detection running

mA 2-Wire Transmitter Simulation	
Accuracy	Same as Source/Power & Measure
Voltage burden	≤ 2V at 20 mA
Overload/Current limit protection	24 mA nominal
Loop voltage limits	2 to 60 VDC (fuse-less protected from reverse polarity connections)

Source Thermocouple	
Accuracy	±(0.008% of Reading + 0.006 mV)
Cold Junction Compensation	± 0.09°F (±0.05 °C) - Thermistor traceable to NIST for 11 years
Millivolt Range	-13.000 to 80.000 mV
Output Impedance	< 0.3 Ohms
Source Current	> 20 mA (drives 80 mV into 10 Ohms)
Noise	≤ 4 microvolts p-p for frequencies of 10 Hz or below

Read Thermocouple	
Accuracy	±(0.008% of Reading + 0.006 mV)
Cold Junction Compensation	± 0.09°F (±0.05 °C) - Thermistor traceable to NIST for 11 years
Millivolt Range	-13.000 to 80.000 mV
Input Impedance	> 10 Megohms
Open Thermocouple Threshold Pulse	18,000 Ohms nominal < 10 microamp pulse for 400 milliseconds

Source Ohms & RTD	
3 & 4 Wire Accuracy From 1 to 10.2 mA External Excitation Current	±(0.015% of Reading + 0.05 Ohms)
Below 1 mA of External Excitation Current	±(0.015% of R <sub>dg</sub> + $\frac{0.025 \text{ mV}}{\text{mA Excitation Current}}$ + 0.05 Ohms)
2 Wire Accuracy*	Add 0.1 Ohms to 3 Wire & 4 Wire Accuracy
Resistance Ranges	400 Ohm Range: 0.00 to 401.00 & 0.000 to 401.000 4000 Ohm Range: 0.0 to 4010.0 & 0.00 to 4010.00
RMS Noise	400 Ohm Range: ≤ ± 0.005 Ohms from 0.1 to 10 Hz 4000 Ohm Range: ≤ ± 0.05 Ohms from 0.1 to 10 Hz
Allowable Excitation Current Range	0 to 400 Ohm: 10.2 mA max; steady or pulsed/intermittent 401 to 4000 Ohms: 1 mA max; steady or pulsed/intermittent
Pulsed Excitation Current Compatibility	DC to 0.01 second pulse width

Read Ohms & RTD	
3 Wire & 4 Wire Accuracy	±(0.015% of Reading + 0.05 Ohms)
2 Wire Accuracy*	±(0.015% of Reading + 0.15 Ohms)
Resistance Ranges	Same as Source Ohms & RTD
Excitation Current	0.9 mA to 401 Ohms, 0.4 mA to 4010 Ohms (nominal)







\* 2 Wire specifications do not include resistance of the lead wires







# Thermocouple Ranges & Accuracies

**Table based on Accuracy:**

$\leq \pm (0.008 \% \text{ of Reading} + 0.006 \text{ mV})$

Note: Doesn't include cold junction error of  $\pm 0.05^\circ\text{C}$

T/C	Degrees C Range	°C	Degrees F Range	°F	T/C Material
<b>J</b> 	-200.00 to -150.00	$\pm 0.25^\circ$	-328.00 to -238.00	$\pm 0.55^\circ$	+Iron -Constantan
	-150.00 to -50.00	$\pm 0.17^\circ$	-238.00 to -58.00	$\pm 0.35^\circ$	
	-50.00 to 300.00	$\pm 0.13^\circ$	-58.00 to 572.00	$\pm 0.24^\circ$	
	300.00 to 850.00	$\pm 0.15^\circ$	572.00 to 1562.00	$\pm 0.28^\circ$	
	850.00 to 1200.00	$\pm 0.20^\circ$	1562.00 to 2192.00	$\pm 0.36^\circ$	
<b>K</b> 	-230.00 to -100.00	$\pm 0.70^\circ$	-382.00 to -148.00	$\pm 1.26^\circ$	+ Chromel® -Alumel®
	-100.00 to 600.00	$\pm 0.19^\circ$	-148.00 to 1112.00	$\pm 0.34^\circ$	
	600.00 to 1000.00	$\pm 0.24^\circ$	1112.00 to 1832.00	$\pm 0.43^\circ$	
	1000.00 to 1371.1	$\pm 0.31^\circ$	1832.00 to 2500.00	$\pm 0.55^\circ$	
<b>T</b> 	-260.00 to -240.00	$\pm 1.66^\circ$	-436.00 to -400.00	$\pm 2.98^\circ$	+Copper -Constantan
	-240.00 to -210.00	$\pm 0.60^\circ$	-400.00 to -346.00	$\pm 1.07^\circ$	
	-210.00 to -100.00	$\pm 0.41^\circ$	-346.00 to -148.00	$\pm 0.74^\circ$	
	-100.00 to 50.00	$\pm 0.18^\circ$	-148.00 to 122.00	$\pm 0.33^\circ$	
	50.00 to 400.00	$\pm 0.14^\circ$	122.00 to 752.00	$\pm 0.24^\circ$	
<b>E</b> 	-240.00 to -225.00	$\pm 0.51^\circ$	-400.00 to -373.00	$\pm 0.92^\circ$	+Chromel -Constantan
	-225.00 to -100.00	$\pm 0.27^\circ$	-373.00 to -148.00	$\pm 0.48^\circ$	
	-100.00 to 750.00	$\pm 0.13^\circ$	-148.00 to 1382.00	$\pm 0.24^\circ$	
	750.00 to 1000.00	$\pm 0.16^\circ$	1382.00 to 1832.00	$\pm 0.29^\circ$	
<b>R</b> 	-18.30 to 250.00	$\pm 1.26^\circ$	-1.00 to 482.00	$\pm 2.27^\circ$	+Pt/13Rh -Platinum
	250.00 to 750.00	$\pm 0.64^\circ$	482.00 to 1382.00	$\pm 1.14^\circ$	
	750.00 to 1600.00	$\pm 0.54^\circ$	1382.00 to 2192.00	$\pm 0.97^\circ$	
	1600.00 to 1767.80	$\pm 0.63^\circ$	2192.00 to 3214.00	$\pm 1.13^\circ$	
<b>S</b> 	-18.30 to 150.00	$\pm 1.22^\circ$	-1.00 to 302.00	$\pm 2.20^\circ$	+Pt/10Rh -Platinum
	150.00 to 500.00	$\pm 0.72^\circ$	302.00 to 932.00	$\pm 1.30^\circ$	
	500.00 to 1650.00	$\pm 0.63^\circ$	932.00 to 3002.00	$\pm 1.14^\circ$	
	1650.00 to 1767.80	$\pm 0.73^\circ$	3002.00 to 3214.00	$\pm 1.31^\circ$	
<b>B</b> 	315.60 to 550.00	$\pm 1.88^\circ$	600.00 to 1022.00	$\pm 3.39^\circ$	+Pt/30Rh -Pt/6Rh
	550.00 to 900.00	$\pm 1.03^\circ$	1022.00 to 1652.00	$\pm 1.86^\circ$	
	900.00 to 1150.00	$\pm 0.72^\circ$	1652.00 to 2102.00	$\pm 1.30^\circ$	
	1150.00 to 1820.00	$\pm 0.63^\circ$	2102.00 to 3308.00	$\pm 1.14^\circ$	

T/C	Degrees C Range	°C	Degrees F Range	°F	T/C Material
<b>N</b> 	-230.00 to -100.00	$\pm 1.10^\circ$	-382.00 to -148.00	$\pm 1.98^\circ$	+Nicrosil -Nisil
	-100.00 to 0.00	$\pm 0.30^\circ$	-148.00 to 32.00	$\pm 0.53^\circ$	
	0.00 to 1100.00	$\pm 0.24^\circ$	32.00 to 2012.00	$\pm 0.44^\circ$	
	1100.00 to 1300.00	$\pm 0.27^\circ$	2012.00 to 2372.00	$\pm 0.49^\circ$	
<b>G (W)</b> 	100.00 to 450.00	$\pm 1.14^\circ$	212.00 to 842.00	$\pm 2.05^\circ$	+Tungsten -W26/Re
	440.00 to 1700.00	$\pm 0.44^\circ$	842.00 to 3092.00	$\pm 0.79^\circ$	
	1700.00 to 2000.00	$\pm 0.54^\circ$	3092.00 to 3632.00	$\pm 0.97^\circ$	
	2000.00 to 2320.00	$\pm 0.73^\circ$	3632.00 to 4208.00	$\pm 1.32^\circ$	
<b>C (W5)</b> 	-1.10 to 1150.00	$\pm 0.44^\circ$	30.00 to 2102.00	$\pm 0.80^\circ$	+W5/Re -W26/Re
	1150.00 to 1750.00	$\pm 0.61^\circ$	2102.00 to 3182.00	$\pm 1.09^\circ$	
	1750.00 to 2050.00	$\pm 0.74^\circ$	3182.00 to 3722.00	$\pm 1.33^\circ$	
	2050.00 to 2320.00	$\pm 0.99^\circ$	3722.00 to 4208.00	$\pm 1.79^\circ$	
<b>D (W3)</b> 	-1.00 to 150.00	$\pm 0.63^\circ$	30.00 to 302.00	$\pm 1.13^\circ$	+W3/Re -W25/Re
	150.00 to 1200.00	$\pm 0.41^\circ$	302.00 to 2192.00	$\pm 0.73^\circ$	
	1200.00 to 1700.00	$\pm 0.51^\circ$	2192.00 to 3092.00	$\pm 0.92^\circ$	
	1700.00 to 2320.00	$\pm 0.97^\circ$	3092.00 to 4208.00	$\pm 1.75^\circ$	
<b>P</b> <small>Platinel®</small>	0.00 to 950.00	$\pm 0.23^\circ$	32.00 to 1742.00	$\pm 0.41^\circ$	+Pd55/Pt31/ Au14 -Au65/Pd35
	950.00 to 1395.00	$\pm 0.34^\circ$	1742.00 to 2543.00	$\pm 0.61^\circ$	
<b>DIN Wire</b>					
<b>L</b> <small>J-DIN</small> 	-200.00 to -100.00	$\pm 0.21^\circ$	-328.00 to -148.00	$\pm 0.38^\circ$	+Iron -Constantan
	-100.00 to 350.00	$\pm 0.13^\circ$	-148.00 to 662.00	$\pm 0.24^\circ$	
	350.00 to 900.00	$\pm 0.15^\circ$	662.00 to 1652.00	$\pm 0.27^\circ$	
<b>U</b> <small>T-DIN</small> 	-200.00 to -150.00	$\pm 0.37^\circ$	-328.00 to -238.00	$\pm 0.66^\circ$	+Copper -Constantan
	-150.00 to 100.00	$\pm 0.22^\circ$	-238.00 to 212.00	$\pm 0.40^\circ$	
	100.00 to 600.00	$\pm 0.15^\circ$	212.00 to 1112.00	$\pm 0.28^\circ$	



## RTD Ranges & Accuracies

Table based on 3 & 4 Wire RTD Accuracy:

≤ ± (0.015 % of Reading +0.05 Ohms)

[Read based on 1.0 mA of fixed excitation current]

RTD Type	Alpha	Degrees C Range	°C	Degrees F Range	°F
Pt 100 Ohm DIN/IEC/JIS 1989 ITS-90	1.3850 (0.00385)	-200.00 to -150.00	±0.1°	-328.00 to -238.00	±0.2°
		-150.00 to 360.00	±0.2°	-238.00 to 660.00	±0.4°
		360.00 to 740.00	±0.3°	660.00 to 1364.00	±0.6°
		740.00 to 850.00	±0.4°	1364.00 to 1562.00	±0.7°
Pt 10 Ohm DIN/IEC/JIS 1989 Based on ITS-90	1.3850 (0.00385)	-200.00 to -120.00	±1.2°	-328.00 to -184.00	±2.2°
		-120.00 to 210.00	±1.4°	-184.00 to 410.00	±2.6°
		210.00 to 370.00	±1.5°	410.00 to 698.00	±2.8°
		370.00 to 650.00	±1.7°	698.00 to 1202.00	±3.1°
Pt 50 Ohm DIN/IEC/JIS 1989 ITS-90	1.3850 (0.00385)	-200.00 to 200.00	±0.3°	-328.00 to 392.00	±0.6°
		200.00 to 550.00	±0.4°	392.00 to 1022.00	±0.8°
		550.00 to 850.00	±0.5°	1022.00 to 1562.00	±1.0°
Pt 200 Ohm DIN/IEC/JIS 1989 ITS-90	1.3850 (0.00385)	-200.00 to -120.00	±0.1°	-328.00 to -184.00	±0.1°
		-120.00 to 180.00	±0.1°	-184.00 to 356.00	±0.2°
		180.00 to 450.00	±0.2°	356.00 to 842.00	±0.3°
		450.00 to 680.00	±0.2°	842.00 to 1256.00	±0.4°
Pt 500 Ohm DIN/IEC/JIS 1989 ITS-90	1.3850 (0.00385)	-200.00 to -90.00	±0.1°	-328.00 to -194.00	±0.1°
		-120.00 to 180.00	±0.1°	-184.00 to 356.00	±0.2°
		180.00 to 450.00	±0.2°	356.00 to 842.00	±0.3°
		450.00 to 680.00	±0.2°	842.00 to 1256.00	±0.4°
Pt 1000 Ohm DIN/IEC/JIS 1989 ITS-90	1.3850 (0.00385)	-200.00 to 170.00	±0.1°	-328.00 to 338.00	±0.1°
		170.00 to 470.00	±0.1°	338.00 to 878.00	±0.2°
		470.00 to 730.00	±0.2°	878.00 to 1346.00	±0.3°
		730.00 to 850.00	±0.2°	1346.00 to 1562.00	±0.4°
Pt 100 Ohm (Burns)	1.3902 (0.003902)	-195.61 to -100.00	±0.1°	-320.10 to -148.00	±0.3°
		-100.00 to 370.00	±0.2°	-148.00 to 698.00	±0.4°
		370.00 to 648.90	±0.3°	698.00 to 1200.00	±0.6°
Pt 100 Ohm (Old JIS 1981)	1.3916 (0.003916)	-200.00 to -140.00	±0.1°	-328.00 to -220.00	±0.2°
		-140.00 to 130.00	±0.2°	-220.00 to 266.00	±0.3°
		130.00 to 370.00	±0.2°	266.00 to 698.00	±0.4°
		370.00 to 648.90	±0.3°	698.00 to 1200.00	±0.6°
Pt 100 Ohm (US Lab)	1.3926 (0.003926)	-200.00 to -140.00	±0.1°	-328.00 to -220.00	±0.2°
		-140.00 to 130.00	±0.2°	-220.00 to 266.00	±0.3°
		130.00 to 380.00	±0.2°	266.00 to 716.00	±0.4°
		380.00 to 610.00	±0.3°	716.00 to 1130.00	±0.5°
Copper 10 Ohm (Minco)	1.4274 (0.004274)	-200.00 to -150.00	±1.2°	-328.00 to -238.00	±2.2°
		-150.00 to 90.00	±1.3°	-238.00 to 194.00	±2.4°
		90.00 to 260.00	±1.4°	194.00 to 500.00	±2.4°
Copper 50 Ohm	1.4280 (0.00428)	-50.00 to 150.00	±0.3°	-58.00 to 302.00	±0.5°
Ni 120 Ohm (Pure)	1.6720 (0.00672)	-80.00 to 260.00	±0.1°	-112.00 to 500.00	±0.2°

## Warranty

Our equipment is warranted against defective material and workmanship (excluding batteries) for a period of three years from the date of shipment. Claims under warranty can be made by returning the equipment prepaid to our factory. The equipment will be repaired, replaced or adjusted at our option. The liability of Practical Instrument Electronics (PIE) is restricted to that given under our warranty. No responsibility is accepted for damage, loss or other expense incurred through sale or use of our equipment. Under no condition shall Practical Instrument Electronics, Inc. be liable for any special, incidental or consequential damage.

## Additional Information

PIE Calibrators are designed, assembled, and calibrated in the USA. This product is calibrated on equipment traceable to NIST and includes a Certificate of Calibration. Test Data is available for an additional charge.

Practical Instrument Electronics recommends a calibration interval of one year. Contact your local representative for recalibration and repair services.



Tilt stand folds out of boot for use on the work bench

Available From:



Practical Instrument Electronics

82 Est Main Street Suite 3.14 Webster, NY 14580

Tel: 585.872.9350 • Fax: 585.872.2638

sales@piecal.com • www.piecal.com

Copyright © 2017 All rights reserved 525Plus-9001 - Rev A 24 October 2017